

DATA SHEET

CHIP RESISTORS

RC1218

5%; 1%



Product Specification – Mar. 09, 2004 V.0

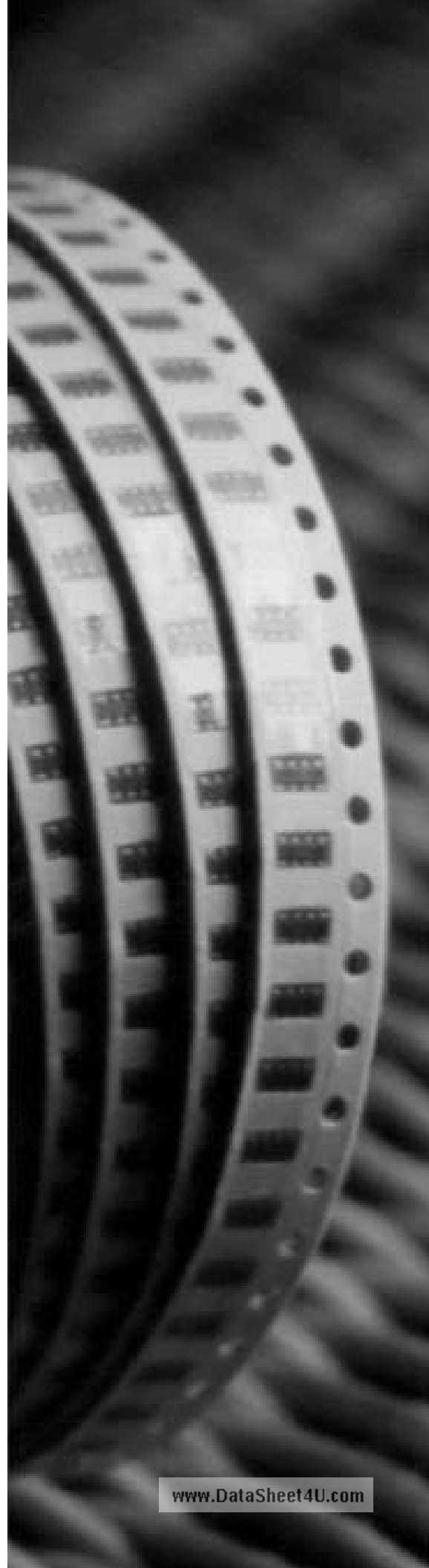

SCOPE

This specification describes RC 1218 series chip resistors made by thick film process.

ORDERING INFORMATION

Part number is identified by the series, size, tolerance, packing style, temperature coefficient, special type and resistance value.

RC1218 X X X XX XXXX
(1) (2) (3) (4) (5)

(1) TOLERANCE

F = $\pm 1\%$

J = $\pm 5\%$

(2) PACKAGING TYPE

K = Embossed taping reel

(3) TEMPERATURE CHARACTERISTIC OF RESISTANCE

F = $\pm 100\text{ppm}/^\circ\text{C}$

G = $\pm 200\text{ppm}/^\circ\text{C}$

- = Base on spec

(4) SPECIAL TYPE

11 = 11 inch dia. Reel

(5) RESISTANCE VALUE:

5R6, 56R, 560R, 5K6, 56K.

MARKING

RC1218

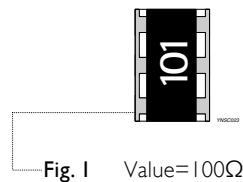

E-24 series: 3 digits

First two digits for significant figure and 3rd digit for number of zeros

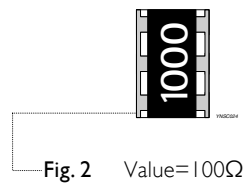

Both E-24 and E-96 series: 4 digits

First three digits for significant figure and 4th digit for number of zeros

CONSTRUCTION

The resistors are constructed out of a high-grade ceramic body. Internal metal electrodes are added at each end and connected by a resistive paste. The composition of the paste is adjusted to give the approximate required resistance and laser cutting of this resistive layer that achieves tolerance trims the value. The resistive layer is covered with a protective coat and printed with the resistance value. Finally, the two external terminations are added. See fig. 3

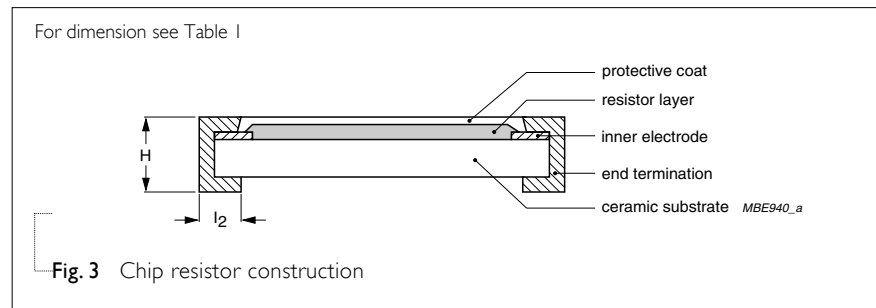

DIMENSION

Table I

TYPE	RC1218
L (mm)	3.10±0.10
W (mm)	4.60±0.10
H (mm)	0.55±0.10
I ₁ (mm)	0.45±0.20
I ₂ (mm)	0.40±0.20

POWER RATING**RATED POWER AT 70°C, RC1218 1W****RATED VOLTAGE:**

The DC or AC (rms) continuous working voltage corresponding to the rated power is determined by the following formula:

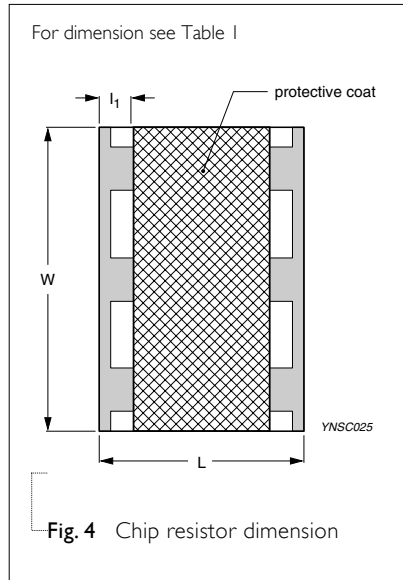
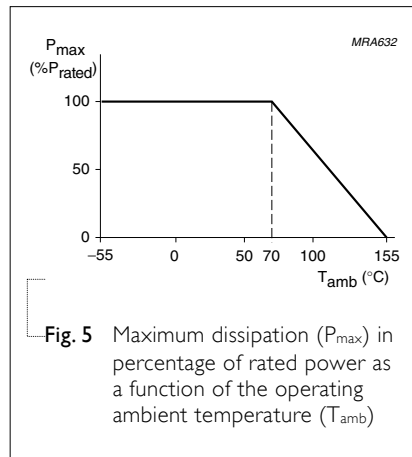
$$V = \sqrt{P \times R}$$

Where

V=Continuous rated DC or AC (rms) working voltage (V)

P=Rated power (W)

R=Resistance value (Ω)

ELECTRICAL CHARACTERISTICS

Table 2

CHARACTERISTICS	RC1218 1W
Operating Temperature Range	-55°C to +155°C
Maximum Working Voltage	200V
Maximum Overload Voltage	400V
Dielectric Withstanding Voltage	500V
Resistance Range	1 Ω to 1M Ω (E24) $\pm 5\%$ 1 Ω to 1M Ω (E24/E96) $\pm 1\%$ Zero Ohm Jumper < 0.02 Ω
Temperature Coefficient	10 Ω < R \leq 1M Ω ± 100 ppm/°C 1 Ω \leq R \leq 10 Ω ± 200 ppm/°C
Jumper Criteria	Rated Current 2.0A Maximum Current 10.0A

TAPING REEL

Table 3

DIMENSION	RC1218
Tape Width	12mm
ØA (mm)	286+0/-1
ØB (mm)	60+1/-0
ØC (mm)	13.0±0.2
W (mm)	13.0±0.3
T (mm)	17.0±1

For dimension see Table 3

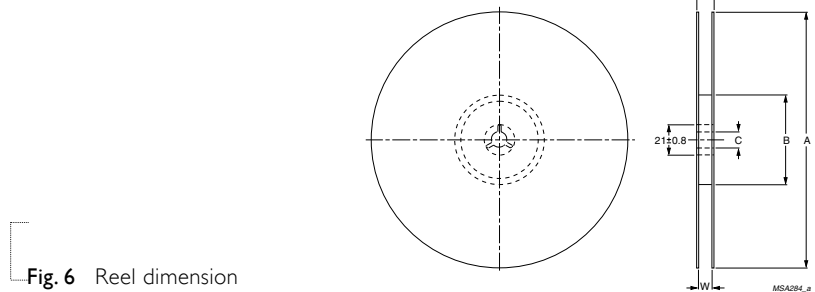

Fig. 6 Reel dimension

EMBOSSED TAPE SPECIFICATION

Table 4

DIMENSION	RC1218
A (mm)	3.5±0.2
B (mm)	4.8±0.2
W (mm)	12±0.3
E (mm)	1.75±0.1
F (mm)	5.5±0.05
P ₀ (mm)	4.0±0.1
P ₁ (mm)	8.0±0.1
P ₂ (mm)	2.0±0.05
ØD ₀ (mm)	1.5±0.1
ØD ₁ (mm)	1.5±0.25
T (mm)	1.0±0.1

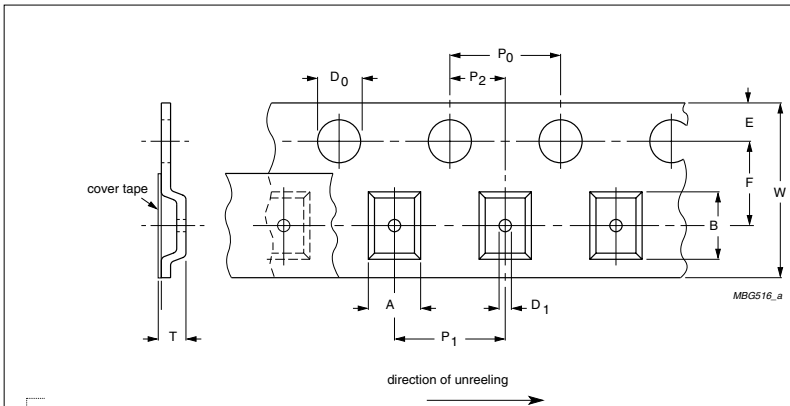

Fig. 7 Embossed tape dimension

For dimension see Table 4

PACKING METHOD**LEADER/TRAILER TAPE SPECIFICATION**

Fig. 8 Leader and trailer tape dimension

Table 5 Packing style and packaging quantity

PACKING STYLE	REEL DIMENSION	RC1218
Embossed Taping Reel (K)	11" (286mm)	5,000

TYPE	TEST METHOD	ACCEPTANCE STANDARD				
Temperature Coefficient of Resistance (T.C.R.)	<p>Measure resistance at +25°C or specified room temperature as R₁, then measure at -55°C or +155°C respectively as R₂.</p> <p>Determine the temperature coefficient of resistance from the following formula:</p>	<p>Formula</p> <hr/> $T.C.R. = \frac{R_2 - R_1}{R_1(t_2 - t_1)} \times 10^6 \text{ (ppm/}^\circ\text{C)}$ <p>Where t₁=+25°C or specified room temperature t₂=-55°C or +155°C test temperature R₁=resistance at reference temperature in ohms R₂=resistance at test temperature in ohms</p>	Refer to table 2			
Thermal Shock	<p>At -55±3°C for 2 minutes and at +155±2°C for 2 minutes as one cycle. After 5 cycles, the specimen shall be stabilized at room temp.</p> <p>Measure the resistance to determine ΔR/R(%) after one more hour.</p>	<p>±(0.5%+0.05Ω) for 1% tol. ±(1%+0.05Ω) for 5% tol.</p>				
Low Temperature Operation	<p>Place the specimen in a test chamber maintained at -65 (+0/-5)°C. After one hour stabilization at this temperature, full rated working voltage shall be applied for 45 (+5/-0) minutes. Have 15 (+5/-0) minutes after remove the voltage, the specimen shall be removed from the chamber and stabilized at room temperature for 24 hrs.</p> <p>Measure the resistance to determine ΔR/R(%)</p>	<p>±(0.5%+0.05Ω) for 1% tol. ±(1.0%+0.05Ω) for 5% tol. No visible damage</p>				
Short Time Overload	<p>Apply 2.5 times of rated voltage but not exceeding the maximum overload voltage for 5 seconds. Have the specimen stabilized at room temperature for 30 minutes minimum.</p> <p>Measure the resistance to determine ΔR/R(%)</p>	<p>±(1.0%+0.05Ω) for 1% tol. ±(2.0%+0.05Ω) for 5% tol. No visible damage</p>				
Insulation Resistance	<p>Place the specimen in the jig and apply a rated continues overload voltage (R.C.O.V) for one minute as shown.</p> <p>Measure the insulation resistance.</p>	<table border="1"> <tr> <td>Type</td> <td>RC1218</td> </tr> <tr> <td>Voltage (DC)</td> <td>400V</td> </tr> </table> <p>≥10,000MΩ</p>	Type	RC1218	Voltage (DC)	400V
Type	RC1218					
Voltage (DC)	400V					
Dielectric Withstand Voltage	<p>Place the specimen in the jig and apply a specified value continuous overload voltage as shown for one minute.</p>	<table border="1"> <tr> <td>Type</td> <td>RC1218</td> </tr> <tr> <td>Voltage (AC)</td> <td>500Vrms</td> </tr> </table> <p>Breakdown voltage> specification and without open/short</p>	Type	RC1218	Voltage (AC)	500Vrms
Type	RC1218					
Voltage (AC)	500Vrms					
Resistance To Soldering Heat	<p>Immerse the specimen in the solder pot at 260±5°C. for 10±1 seconds. Have the specimen stabilized at room temperature for 30 minutes minimum.</p> <p>Measure the resistance to determine ΔR/R(%)</p>	<p>±(0.5%+0.05Ω) for 1% tol. ±(1.0%+0.05Ω) for 5% tol. No visible damage</p>				

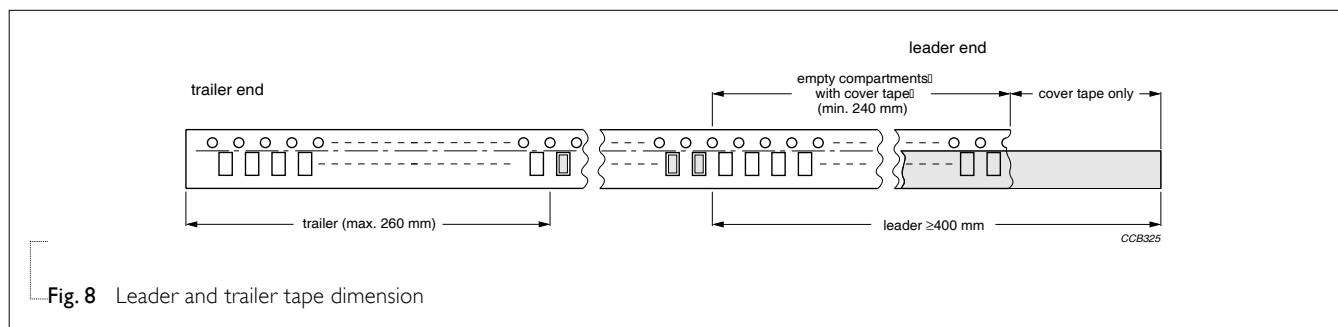
TYPE	TEST METHOD	ACCEPTANCE STANDARD
Moisture Resistance	Place the specimen in the test chamber and subject to 42 damp heat cycles. Each one of which consists of the steps 1 to 7 as figure 10. The total length of test is 1,000 hours. Have the specimen stabilized at room temperature for 24 hours after testing. Measure the resistance to determine $\Delta R/R(\%)$.	$\pm(0.5\%+0.05\Omega)$ for 1% tol. $\pm(2.0\%+0.05\Omega)$ for 5% tol. No visible damage
Life	Place the specimen in the oven at $70\pm 2^\circ\text{C}$. Apply the rated voltage to the specimen at the 1.5 hours on and 0.5 hour off cycle. The total length of test is 1,000 hours. Have the specimen stabilized at room temperature for one hour minimum after testing. Measure the $\Delta R/R(\%)$.	$\pm(1\%+0.05\Omega)$ for 1% tol. $\pm(3\%+0.05\Omega)$ for 5% tol. No visible damage
Solderability	Immerse the specimen in the solder pot at $235\pm 5^\circ\text{C}$ for 2 sec.	At least 95% solder coverage on the termination
Bending Strength	Mount the specimen on a test board as shown in the figure 9. Slowly apply the force till the board is bent for 5 ± 1 sec. Measure the $\Delta R/R(\%)$ at this position.	$\pm(1.0\%+0.05\Omega)$ for 1% tol. $\pm(1.0\%+0.05\Omega)$ for 5% tol. No visible damage

Type	RC1218
------	--------

Bent Distance (d)	2mm
-------------------	-----

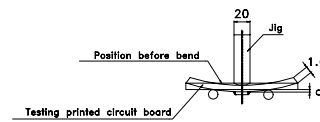

Fig. 9 Principle of the bending test

